

Installation guide

ESMARM



M4X12MM A(4PCS) M5X12MM B(4PCS) M6X12MM C(3PCS)  $\phi$  6.5X  $\phi$  13X1.8 D(8PCS) 4X4 Allen key E(1PCS) 5X5 Allen key F(1PCS)

①	Bottom support 1	1PCS	
②	Screw	1PCS	1
③	Washer	1PCS	
④	Butterfly knob	1PCS	
⑤	Bottom support 2	1PCS	2
⑥	Knob	1PCS	
⑦	Cable cover 1	1PCS	3
⑧	Nylon ties	6PCS	
⑨	Anti-slip rubber 1	1PCS	
⑩	Anti-slip rubber 2	1PCS	
⑪	Anti-slip rubber 3	1PCS	
⑫	Cable cover 2	1PCS	
⑬	M6 box wrench	1PCS	

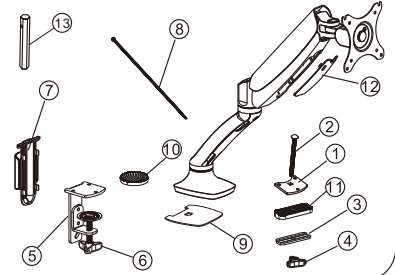

## STEP1

### Preparations before installing monitor

1. Make sure there are VESA holes 100x100mm or 75x75mm in the monitor. If not, the mount couldn't be installed.
2. Remove the original fixed base of monitor. Be careful not to scratch the screen.

75x75 or 100x100

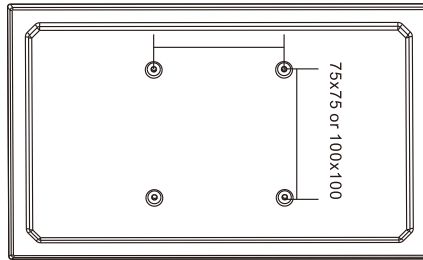

## STEP2-A

### Option 1: Clamp

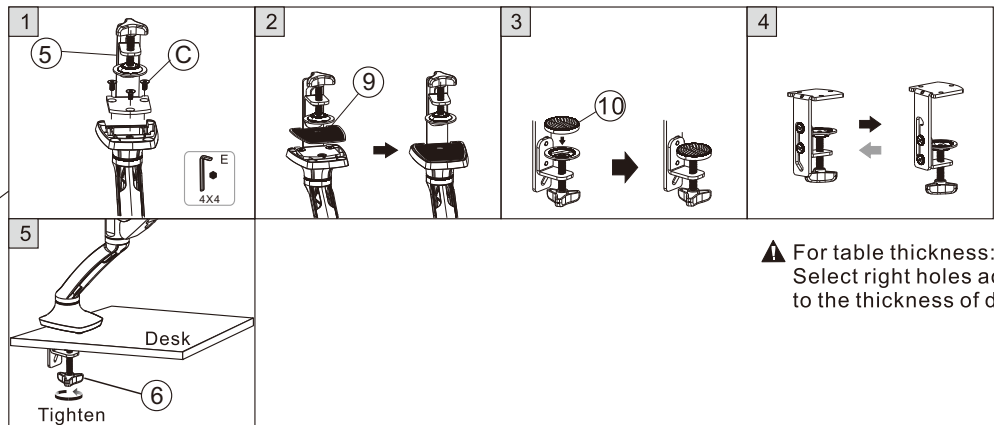
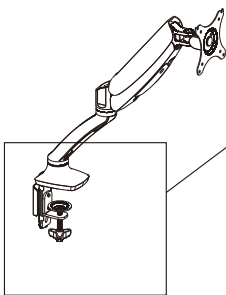

▲ For table thickness: 20-100mm  
Select right holes according to the thickness of desk

## STEP2-B

### Option 2:Grommet

▲ For table thickness:25-90mm

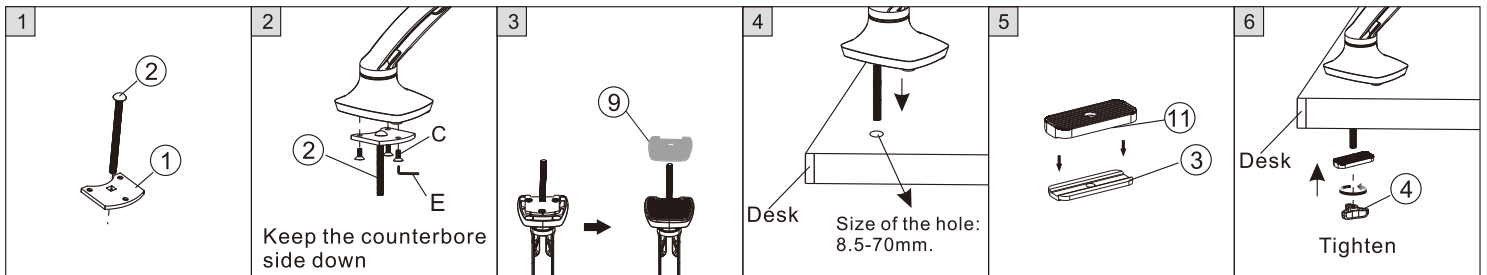

## STEP3

### Attaching the monitor to the plate

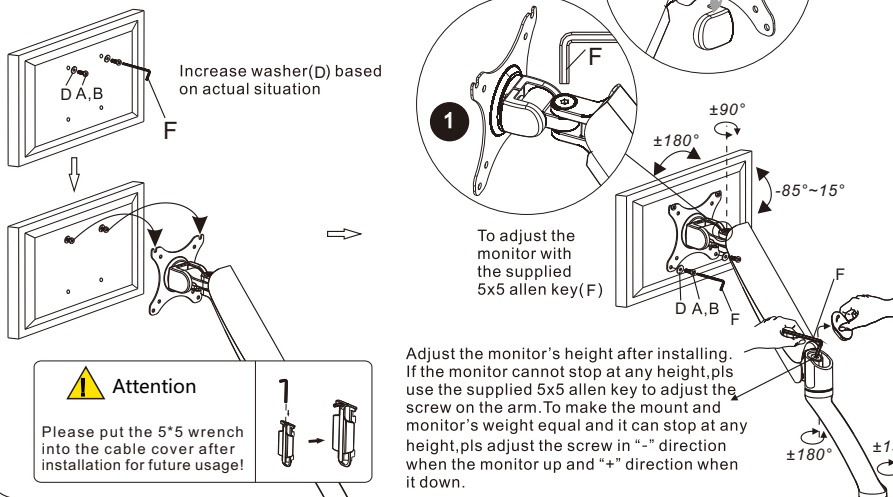

## STEP4

### Using cord management

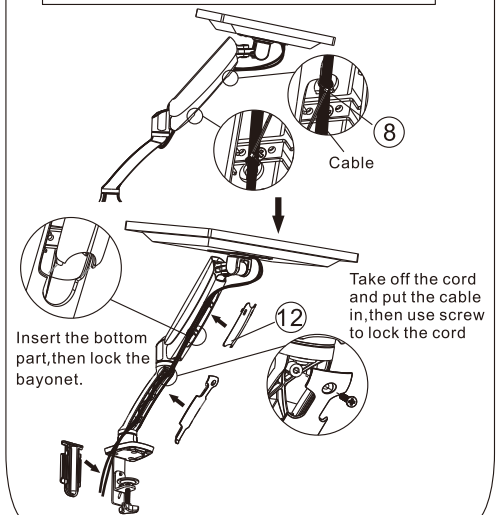

## CAUTION

This product contains small items that could be a choking hazard if swallowed. Keep these items away from young children.

- Make Sure these instructions are read and completely understood before attempting installation. If you are unsure of any part of this installation, please contact a professional installer for assistance.
- The desk or mounting surface must be capable of supporting the combined weight of the mount and the display, otherwise the structure must be reinforced.
- please check joint parts every two months, making sure the screws are loosened or not.

This product was designed to be installed on desk. Before installing, make sure the mount will support the combined load of the equipment and hardware. Never exceed the maximum load capacity 9 KG, or else it may result in product failure or personal injury.

Note: this product is intended for indoor use only. Use of this product outdoors could lead to product failure or personal injury.

**Warning:** This product contains high pressure gas spring parts, please do not put it into fire, high temperature, or disassemble it, which will lead to unexpected personal injury. The obsolete products can be sent back to the manufacturer or handed over to professional institutions.

To ensure the sealing performance of the gas spring, it is suggested to have complete adjustment to the upper arm (with spring) one time or several times every month.